

Pathway Connectivity, Modular Receptacles

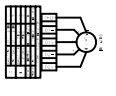

Pinout
5 Pin Male XLR
DMX IN

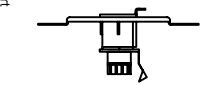
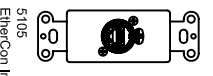
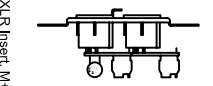
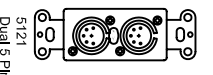
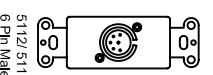
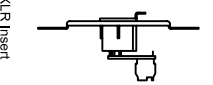
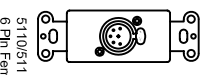
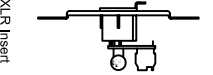
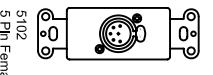
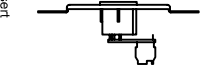
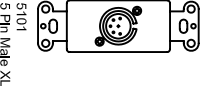
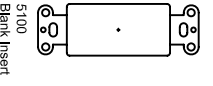
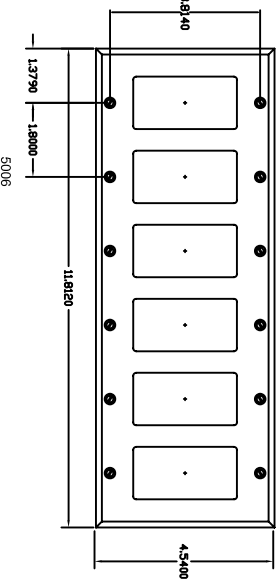
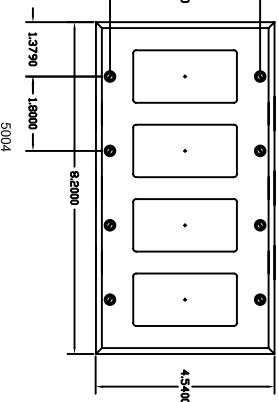
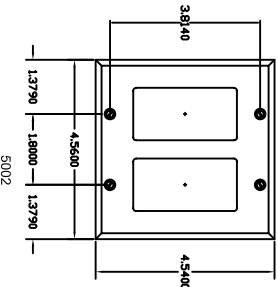
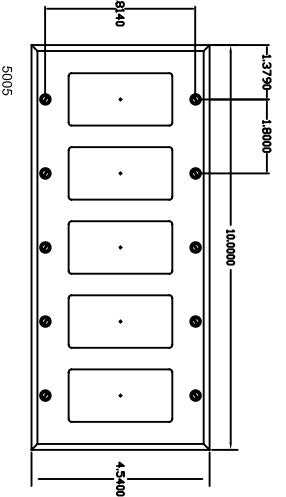
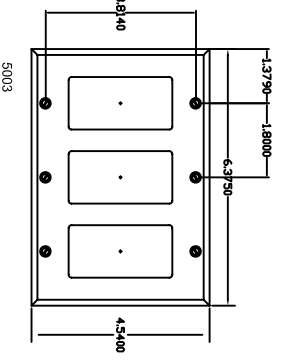
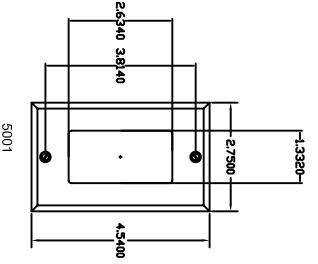
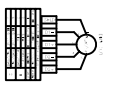

Pinout
5 Pin Female XLR
DMX OUT

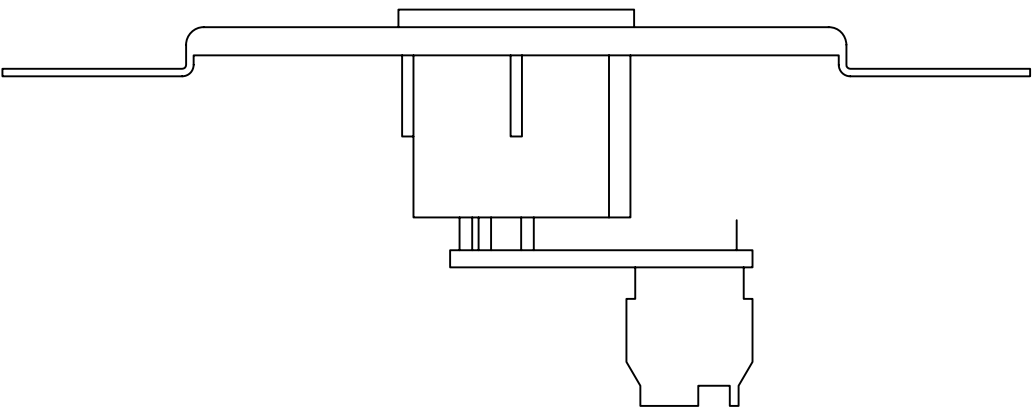
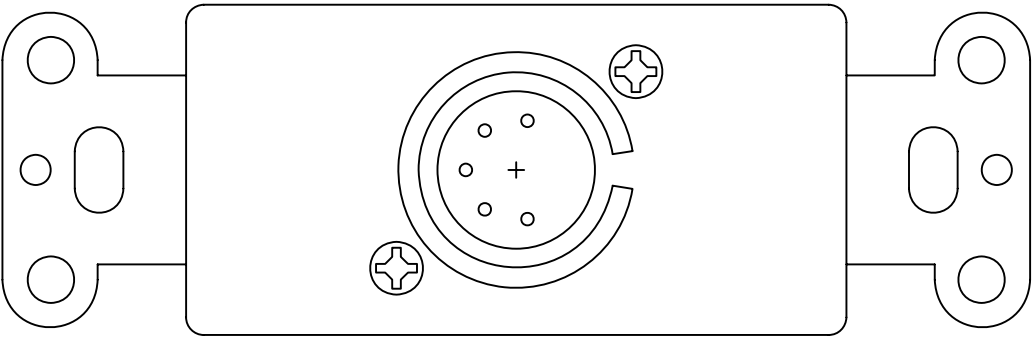

5101 5 Pin Male XLR Insert

FILENAME: PART NUMBER: 5101



Pathway Connectivity Inc.
 480C - 36 Avenue S.E.
 Calgary, Alberta, T2G 1W4, Canada
 Phone: +1(403)243-8110 Fax: +1(403)287-1281
<http://www.pathwayconnect.com>

DRAWN BY:
 DATE:
 CHECKED:
 SCALE: NTS
 UNITS: INCHES

REV

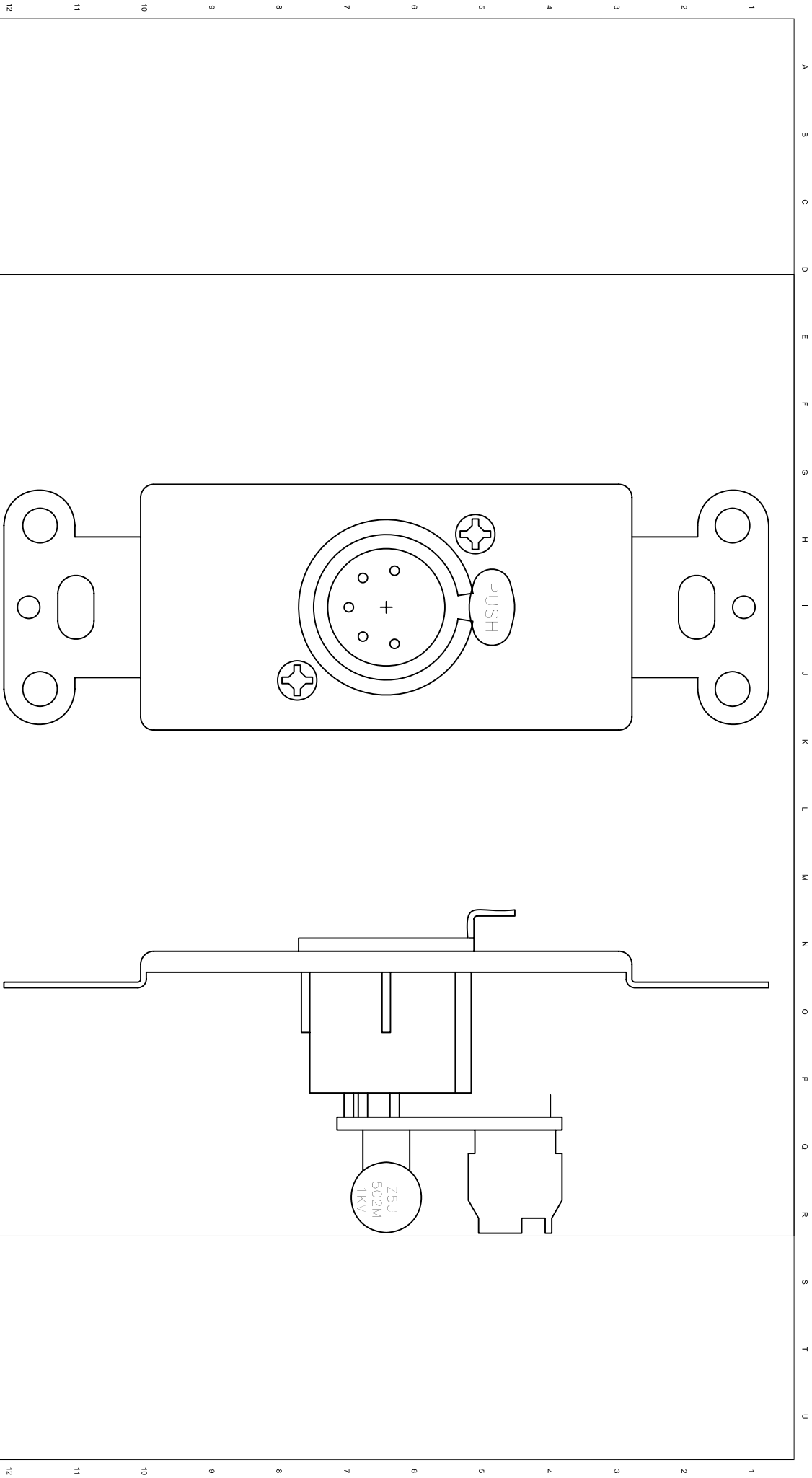

13
 FILENAME: 5102 5 Pin Female XLR Insert
 PART NUMBER: 5102



Pathway Connectivity Inc.
 480C - 36 Avenue S.E.
 Calgary, Alberta, T2G 1W4, Canada
 Phone: +1(403)243-8110 Fax: +1(403)287-1281
<http://www.pathwayconnect.com>

REV
 DRAWN BY:
 DATE:
 CHECKED:
 SCALE: NTS
 UNITS: INCHES

A B C D E F G H I J K L M N O P Q R S T U

1
2
3
4
5
6
7
8
9
10
11
12

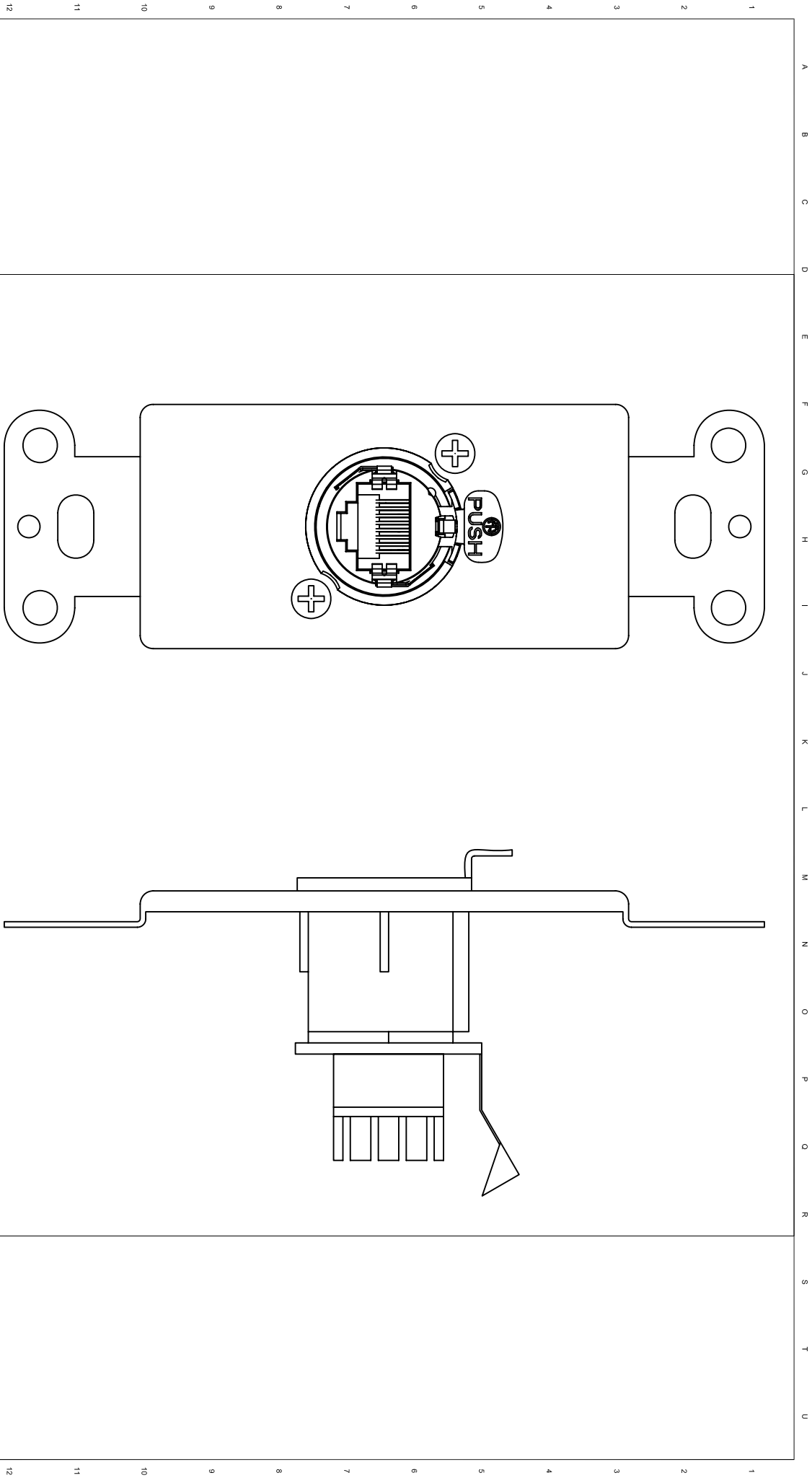

13
 FILENAME: 5105 RJ45 Cat5 Insert
 PART NUMBER: 5105



Pathway Connectivity Inc.
 480C - 36 Avenue S.E.
 Calgary, Alberta, T2G 1W4, Canada
 Phone: +1(403)243-8110 Fax: +1(403)287-1281
<http://www.pathwayconnect.com>

DRAWN BY:	REV
DATE:	
CHECKED:	
SCALE: NTS	
UNITS: INCHES	

A B C D E F G H I J K L M N O P Q R S T U

12 11 10 9 8 7 6 5 4 3 2 1

12 11 10 9 8 7 6 5 4 3 2 1

5112/5113 6 Pin Male XLR Insert

5112/5113



NTS
INCHES



13

12

11

10

9

8

7

6

5

4

3

2

1